



PIR-234-E/PIR-234-WF PIR-234L-E/PIR-234L-WF

Motion, Temperature, and Humidity Sensor Module

Features

- Adjustable Time-Delay
- 4 PIR Motion Sensors for increased sensitivity and range
- Internal Photosensor for Smart Switch Control
- LED Indicator for PIR/Temperature Sensor
- Temperature Sensor for Measuring Room Temperature
- Suitable as either Temperature or Fire Alarm
- Relay Output Can be Used to Control Light Via the PIR/Temperature Sensor
- Provide High Power Relay Output to turn ON/OFF the Lighting
 - Support Lighting Module (Max.):
 - Incandescent Lamp: 40 W/ 220 VAC * 8 Sets
 - LED(Electronic ballast): 40 W/ 220 VAC * 10 Set
- Wide range of Communication Interfaces and Protocols
- Compatible with IEEE802.11b/g/n standards (PIR-234-WF, PIR-234L-WF Only)
- Support infrastructure and limit-AP modes for wireless networks (PIR-234-WF, PIR-234L-WF Only)
- Ceiling or Surface-Mount Design
- PIR-234-WF, PIR-234L-WF no CE ,FCC and UKCA Certification



Introduction

PIR-234/PIR-234L series modules have 4 PIR Motion Sensors to increase sensitivity and the ability to detect infrared waves generated by the human body within a diameter of approximately 9 and 14 meters, with a coverage area of 360° for indoor motion detection. The modules can be configured to automatically switch on a light if motion is detected. The modules also contain a temperature and humidity sensor for measuring indoor temperature and humidity, or it can be configured to activate a fire alarm. A wide range of interface connections can be selected to suit individual needs, including RS-485/Ethernet/Wi-Fi, provide support for the DCON and Modbus RTU/TCP protocols, and can be easily integrated into existing HMI/SCADA/central control systems.

The screw-free quick-connect connector and the DIP and rotary switches make the modules easy to install, repair, and maintain. The casing of each module is made from UL94-V2 rated fireproof material, and the white minimalist exterior design ensures that it is easy to match with interior decoration.

Applications

- Common lighting in staircases
- Garden lights
- Lighting for changing rooms in shops
- Lighting for Conference Room, Classroom, Pantry Room
- Corridor lighting, and many more situations



Specifications

Model	PIR-234-E	PIR-234-WF	PIR-234L-E	PIR-234L-WF
EMS Protection				
EFT (IEC 61000-4-4)	±4 kV for Power Line			
ESD (IEC 61000-4-2)	±4 kV Contact for each Terminal, ±8 kV Air for Random Point			
LED Indicators				
Status	Yes,1 as Power/Communication Indicator. 1 as Alarm Indicator.			
PIR				
Sensor	4			
Delay Time	Hardware: 8-step Switch-selectable (seconds): 6, 16, 33, 66, 131, 262, 524, 1049 Software: 16-step (seconds): 2, 4, 6, 8, 16, 33, 49, 66, 131, 262, 393, 524, 1049, 2097, 3146, 4194			
Detection Height	4 m Max.			
Detection Field of View	360°; 9 m Diameter Max.		360°; 14 m Diameter Max.	
PIR Response Time	1 second			
Temperature Measurement				
Range	-40 to +120°C			
Fire Alarm	65°C (Programmable)			
Resolution	0.01°C			
Accuracy	±0.5°C (at 0 to 60°C)			
Humidity Measurement				
Range	0 to 100% RH			
Resolution	0.01% RH			
Accuracy	±5% RH			
Wi-Fi				
Transmission Distance (LoS)	-	50 m (LOS)	-	50 m (LOS)
Standard Supported	-	Wi-Fi: IEEE 802.11 b/g/n	-	Wi-Fi: IEEE 802.11 b/g/n
Mode	-	Infrastructure/Limited AP	-	Infrastructure/Limited AP
Encryption	-	WEP, WPA ,WPA2	-	WEP, WPA ,WPA2
Relay Output				
Channels	2			
Type	Power Relay, Form A (SPST N.O.)			
Contact Rating	16 A @ 250 VAC or 16 A @ 30 VDC			
Number of Lighting Fixture	(1).Incandescent Lamp: 40W/ 220VAC * 8 Sets (2).LED(Electronic ballast): 40W/ 220VAC *10 Sets			
COM Ports				
Ports	RS-485 X 1 and Ethernet/PoE X1			
Baud Rate	1200, 2400, 4800, 9600, 19200, 38400, 57600, 115200			
Protocol	DCON, Modbus RTU, Modbus TCP, MQTT			
Node Address	Hardware: 160 to 191 / Software: 1 to 255			
Power				
Reverse Polarity Protection	Yes			
Input Range	18 to 48 VDC, PoE			
Consumption	2 W	3 W	2 W	3 W
Mechanical				
Dimensions (mm)	Ø150 x 53 (Ø x H)			
Installation	Ceiling /surface mounted			
Ingress Protection Rating	IP20			
Environment				
Operating Temperature	0 to +35°C			
Storage Temperature	-30 to +80°C			
Humidity	10 to 90% RH, Non-condensing			

Operating Distance

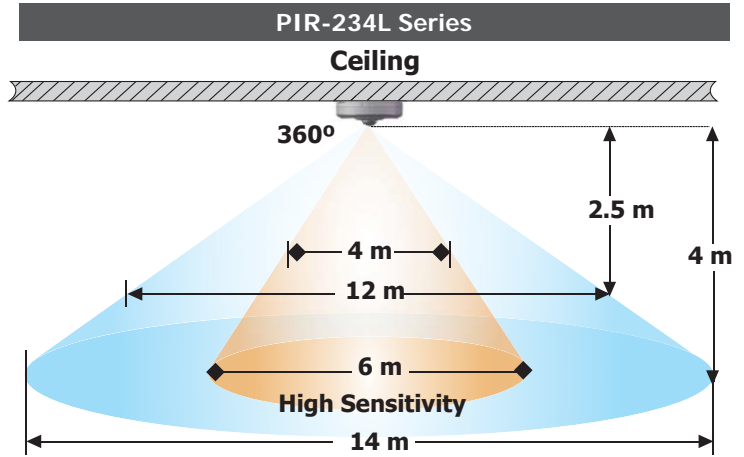
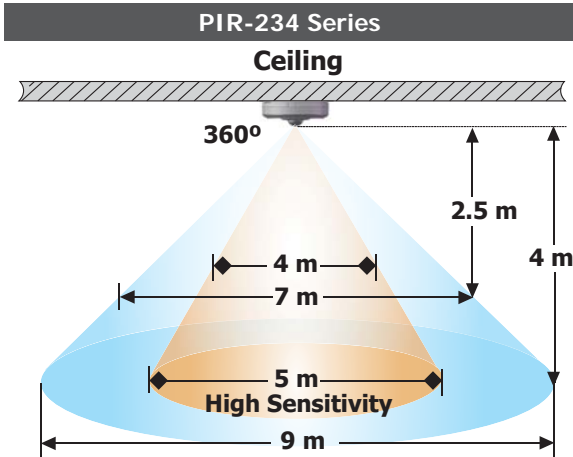

Pin Assignments

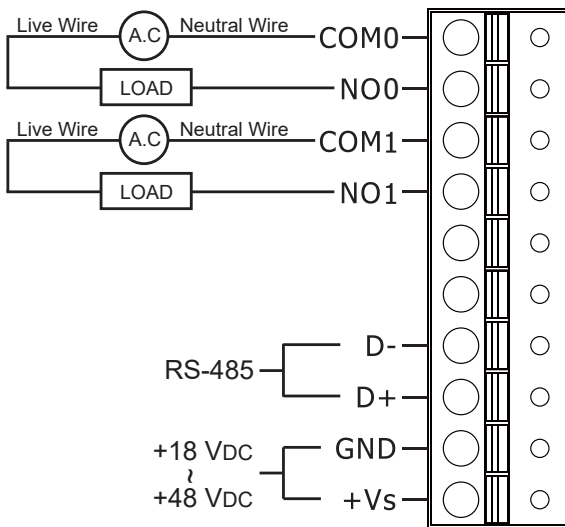

DIP Switch Settings

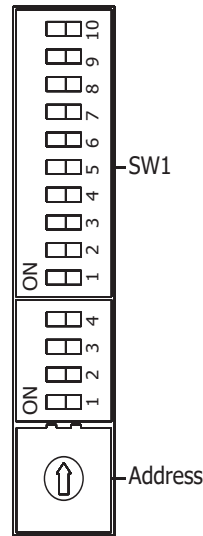

SW1	ON	OFF
10	ON Time Control	
9		
8		
7	DO Control	
6		
5		
4	INIT	Run
3	High Node	Low Node
2	SW Config.	HW Config.
1	DCON	Modbus
4	Enable PIR	Disable PIR
3		
2		
1		

Mounting

Ceiling Mounting

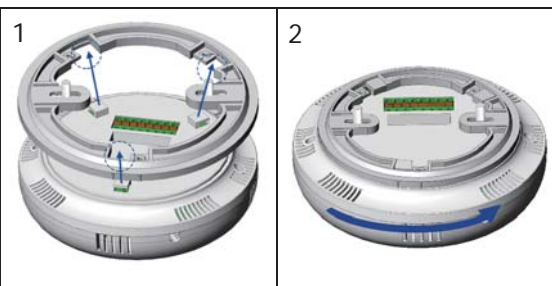

Wall Mounting (+ External Wall Box EWB-C150)

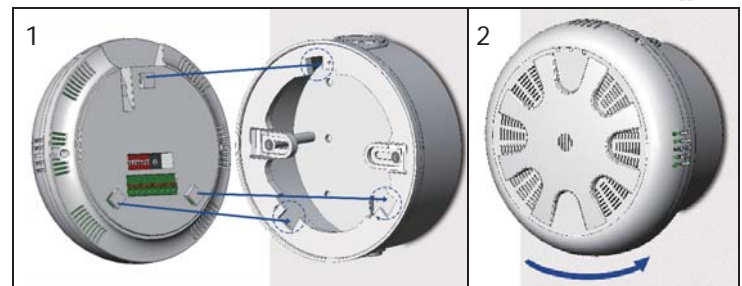

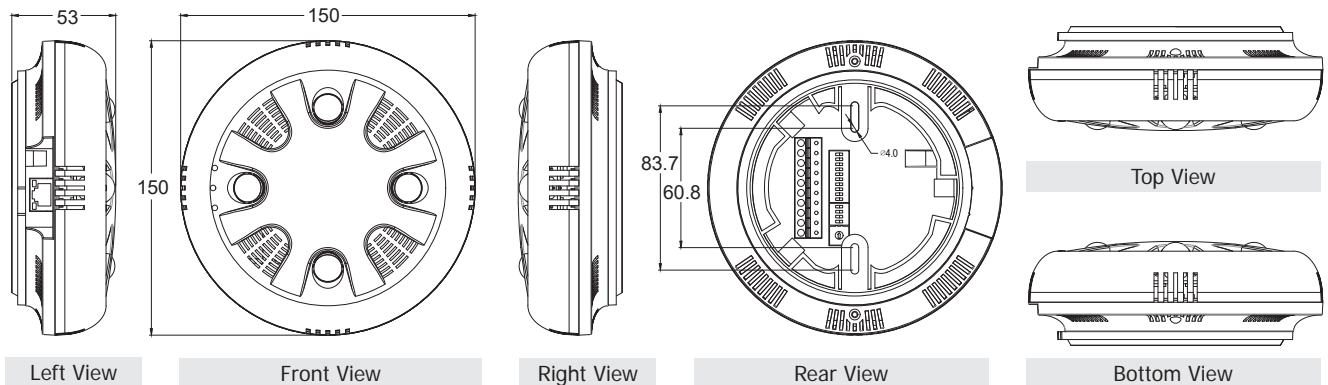

Dimensions (Units: mm)







Ordering Information

PIR-234-E CR	PIR Motion Sensor, Temperature and Humidity Sensor Module(High Sensitivity / Height 4 m / Diameter 9 m)(Ethernet) (RoHS)
PIR-234-WF CR	PIR Motion Sensor, Temperature and Humidity Sensor Module(High Sensitivity / Height 4 m / Diameter 9 m)(Wi-Fi)(Asia Only) (RoHS)
PIR-234L-E CR	PIR Motion Sensor, Temperature and Humidity Sensor Module(High Sensitivity / Height 4 m / Diameter 14 m)(Ethernet) (RoHS)
PIR-234L-WF CR	PIR Motion Sensor, Temperature and Humidity Sensor Module(High Sensitivity / Height 4 m / Diameter 14 m)(Wi-Fi)(Asia Only)(RoHS)

Accessories

EWB-C150		External Wall Box for PIR-200 series
CA-RJ45-04		RJ45 Cable, Male-Female, 30cm

Selection Guide

	Human Motion Detection			Human Presence Detection	
	PIR-130-AC PIR-130-DC	PIR-230-E PIR-230-WF	PIR-231-E PIR-231-WF	PIR-234-E PIR-234-WF	PIR-234L-E PIR-234L-WF
Model					
Applications	Corridors, Toilet, Stairwells, Shoe Changing Area/ Entrance Area		Hotel, Labby, High-Ceiling Factory/Warehouse	Meeting Room, Bedroom, Living Room, Locker Room, Pantry Room	Conference Room, Classroom
Sensitivity	standard		standard	High	High
Detection Height Max.	4 m		10 m	4 m	4 m
Diameter Max.	8 m		8 m	9 m	14 m
Operating Distance	