



## I-2533

CAN to Fiber Bridge

### Features

- Fiber Port: ST (Multi-mode)
- Maximum transmission distance up to 2 km at any CAN baud rate
- 82C250 CAN transceiver
- 2500 Vrms iCoupler isolation on the CAN side
- Support both CAN 2.0A and CAN 2.0B specification
- Fully compatible with the ISO 11898-2 standard
- Built-in switch for 120 Ω terminal resistor
- Up to 100 CAN nodes on the CAN channel
- Removable terminal block
- Mount easily on DIN-Rail
- Rotary switch for CAN baud rate configuration
- Allow user-defined baud rate
- Fiber broken line detection
- Utility tool for message filter configuration



### Introduction

The I-2533 is a local CAN bridge used to establish a connection between two CAN bus systems via fiber optic transmission medium. By using I-2533, the transmission distance limitation of the fiber optic system will not decrease due to the higher CAN baud rate. It means that the total network distance can be extended. Moreover, the bus error on one CAN network don't affect the operation of another CAN network. The two CAN network can communicate with each other by using different CAN baud rate for highly flexibility. These features help users' applications more powerful and flexible.

### Hardware Specifications

CAN Interface	
Connector	Screwed terminal block (CAN_GND, CAN_L, CAN_H)
Baud Rate (bps)	10 k ~ 1 M
Transmission Distance (m)	Depend on baud rate
Terminal Resistor	Switch for 120Ω terminal resistor
Isolation	3000 V <sub>DC</sub> for DC-to-DC, 2500 Vrms for photo-couple
Specification	ISO-11898-2, CAN 2.0A and CAN 2.0B
Time Delay	120us max (CAN to fiber or fiber to CAN)
Fiber Interface	
Connector	ST (Multi-mode)
Wave Length	850 nm
Fiber Cable	50 / 125 μm , 62.5 / 125 μm, 100 / 140 μm (62.5 / 125μm is recommended)
Transmission Distance (m)	2 km max (in 62.5 / 125 μm fiber cable) at any CAN baud rate
LED	
Round LED	PWR LED, CAN_Tx LED, CAN_Rx LED, CAN_Err LED, FB_Err LED
Power	
Power supply	Unregulated +10 ~ +30 V <sub>DC</sub>
Protection	Power reverse polarity protection, Over-voltage brown-out protection
Power Consumption	3 W
Mechanism	
Installation	DIN-Rail
Dimensions	32.3mm x 77.5mm x 99.0mm (W x L x H)
Environment	
Operating Temp.	-25 ~ 75 °C
Storage Temp.	-30 ~ 80 °C
Humidity	10 ~ 90% RH, non-condensing

## Block Diagram

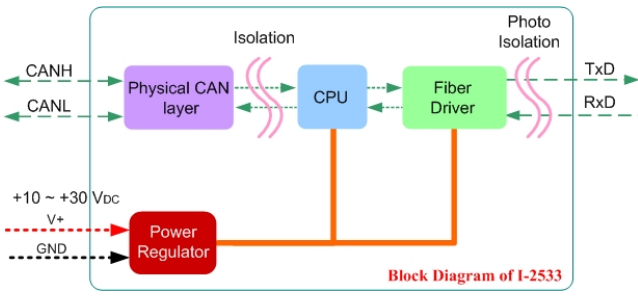

## Maximum Fiber Length

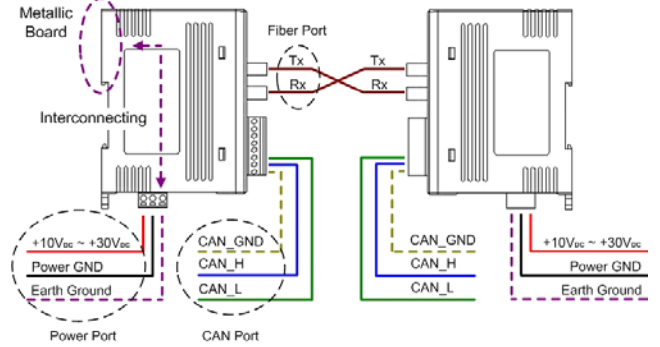

## Pin Assignments

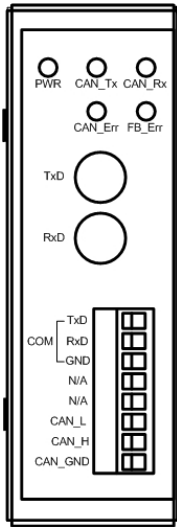

NO.	Pin name
TxD	FiberTxD
RxD	FiberRxD
1	COM TxD
2	COM RxD
3	COM GND
4	N/A
5	N/A
6	CAN_L
7	CAN_H
8	CAN_GND

## Dimensions (Units: mm)

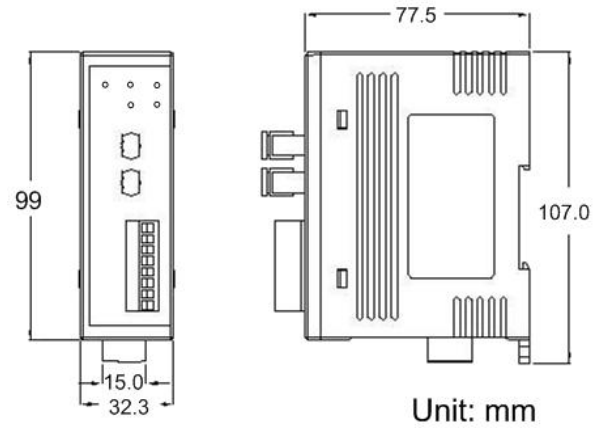

## Application

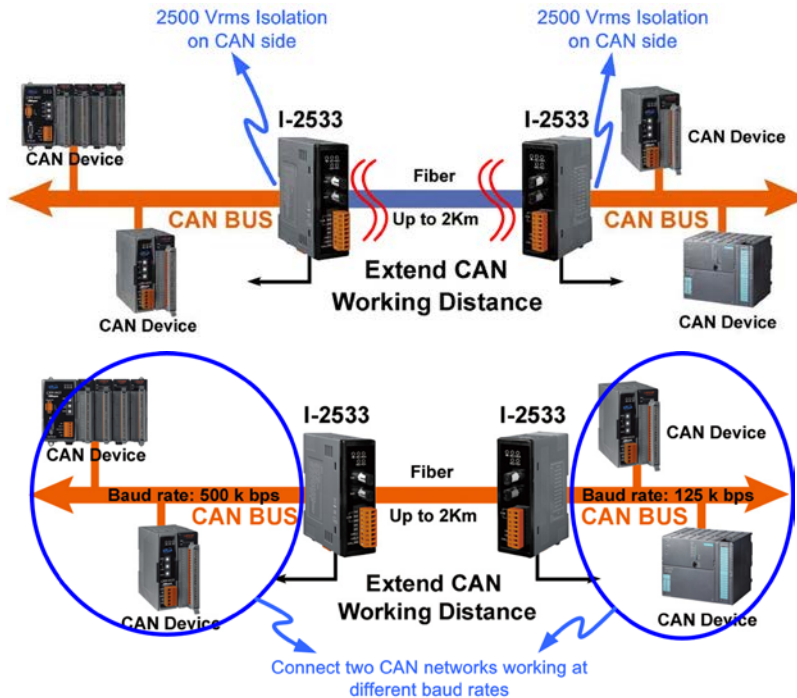

## Ordering Information

I-2533 CR	CAN to fiber bridge (RoHS)
-----------	----------------------------